

VSWD-INT300

INTERIOR LIGHT

R10

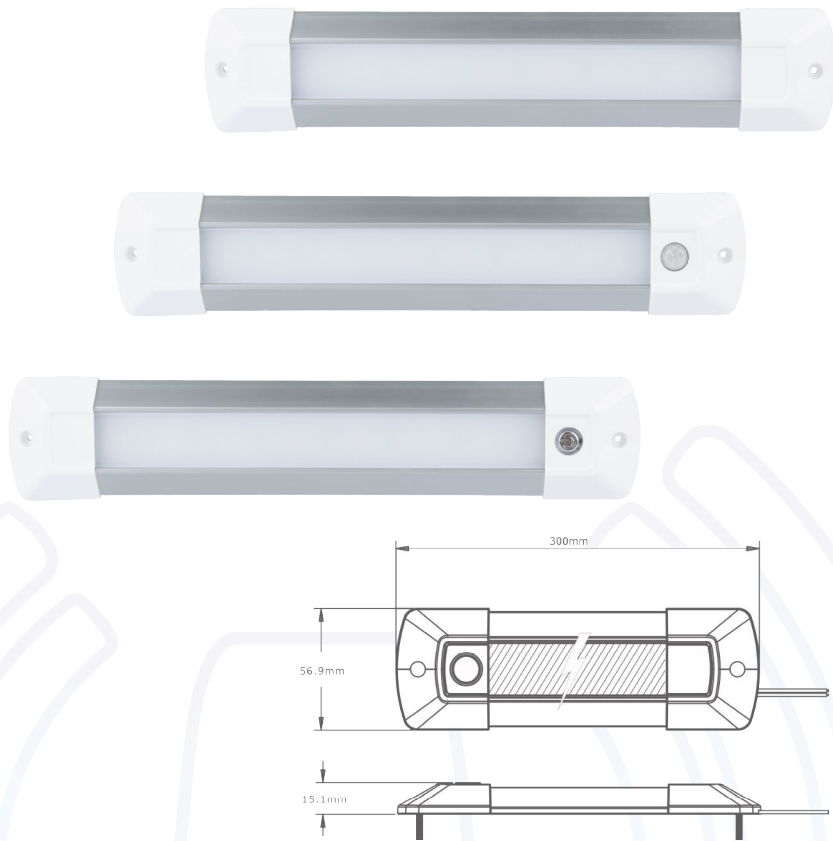

Part Number	Description
VSWD-INT300	Interior Light 300mm 54 LED
VSWD-INT300-02	Interior Light 300mm 54 LED with Switch
VSWD-INT300-03	Interior Light 300mm 54 LED with PIR

Lumens	756	Approvals	ECE R10
Voltage	10-30v	IP Rating	IP67
LEDs	54 LEDs	Colour Temp	5700K - 6500K
Mounting	Surface	Additional Features	Wires Only, Touch Switch with Dimming Function, PIR
Dimensions	300 x 57 x 15mm	Box Qty	40
Housing Material	Aluminium	Lens Material	Polycarbonate